



# INSTRUCTION MANUAL

## EW3070

**HYDRO C1** Corded Compact Carpet Cleaner

Ewbank has a British heritage to be proud of. It's a household favourite and much loved brand that has been providing innovative cleaning solutions for over 140 years.



# CONTENTS

Safety Instructions.....	3 - 6
Appliance Overview .....	7
Product Assembly .....	8
Operating Instructions.....	9 - 11
Cleaning & Maintenance .....	12 - 13
Troubleshooting .....	14 - 15
Specifications .....	16
Fuse Replacement.....	17
Disposal of the Appliance .....	17
Warranty Terms & Conditions .....	18

## **SAVE THESE INSTRUCTIONS**

### **Household use only.**

#### **Carefully read this manual before using this appliance.**

- Ensure that you know how the appliance functions and how to operate it
- Maintain the appliance in accordance with the instructions to ensure that it functions properly
- Keep this manual with the appliance. If the appliance is to be used by a third party, this instruction manual must be supplied with it
- The safety instructions do not by themselves eliminate any danger completely and proper accident prevention measures must always be used
- No liability can be accepted for any damage caused by non-compliance with these instructions or any other improper use or mishandling
- Do not use this appliance if it has been dropped or damaged in any way, or if the supply cord or main plug is damaged

#### **Intended Use**

- The product is exclusively designed for cleaning carpets
- It is only intended for private use and not suitable for commercial purposes
- Do not use the appliance for anything other than its intended purpose, and only use it as described in this manual
- Do not use any accessories with the appliance that are not supplied or specifically recommended

- When using electric appliances always observe safety regulations where applicable to reduce the risk of fire, electric shock and personal injury
- Always check that the power supply corresponds to the voltage on the rating plate

### **Supply Cord and Plug**

- Always unplug from mains supply when not in use
- Do not abuse or damage the power cord; if the supply cord is damaged, it must be replaced by the manufacturer or a qualified engineer or a similarly qualified person in order to avoid a hazard
- Do not carry by the cord, use cord as a handle, close door on cord, or pull cord around sharp edges or corners
- Do not run appliance over cord
- Keep cord away from heated surfaces
- When cleaning or putting the appliance away, switch off the appliance and always pull out the plug from the socket (pull on the plug, not the cable)

### **Double Insulation Safety**

- This appliance is double insulated for your protection
- Do not attempt to repair a double-insulated appliance

### **Use and Environment**

Improper handling of the product may result in damage to the product.

- Never expose the product to high temperatures (heaters etc.) or to the effects of the weather (rain etc.)
- Stop using the product if any of the parts are cracked, broken, or deformed
- Only replace damaged parts with corresponding original spare parts

- Do not use the product to suck up any liquid other than the cleaning solution dispensed from it
- Do not use the product to suck up such wet or damp materials as mud, tile grout, plaster filler, or caulking
- Do not use the product without the tanks in place
- Do not use the product with an external timer or separate remote control system
- Do not put any object into openings
- Do not use with any opening or outlet blocked
- Keep free of dust, lint, hair and anything that may reduce airflow
- Keep hair, loose clothing, fingers and all parts of the body away from openings and moving parts
- Use extra care when cleaning on stairs
- This appliance is designed exclusively for private, domestic use and is not suitable for commercial or industrial use
- Do not use this appliance for any purpose other than those stated in this manual.

## **Supervision**

- This appliance is not intended for use by persons (including children) with reduced physical, sensory or mental capabilities or lack of experience and knowledge unless they have been given supervision or instruction concerning use of the appliance by a person responsible for their safety
- Children should be supervised to ensure that they do not play with the appliance

**Damaged or Dropped**

- Always inspect your appliance before use. Check parts are correctly attached
- Do not use this appliance if it has been damaged, dropped, left outdoors or dropped in water; return it to an authorised service dealer for examination and repair

**Water**

- Do not immerse appliance or power cord in water
- Do not handle with wet hands or use in damp situations
- Do not expose to rain
- To reduce the risk of electric shock, do not use outdoors or on wet surfaces
- Do not use the appliance to dispose of wet or damp materials such as mud, tile grout, plaster filler, or caulking
- Only use the product indoors
- Do not use the product in damp rooms or in the rain
- Do not place the product such that there is a risk of it falling into a tub or sink
- Never reach to retrieve an electrical device if it has fallen into water; in such a case, immediately disconnect the mains plug

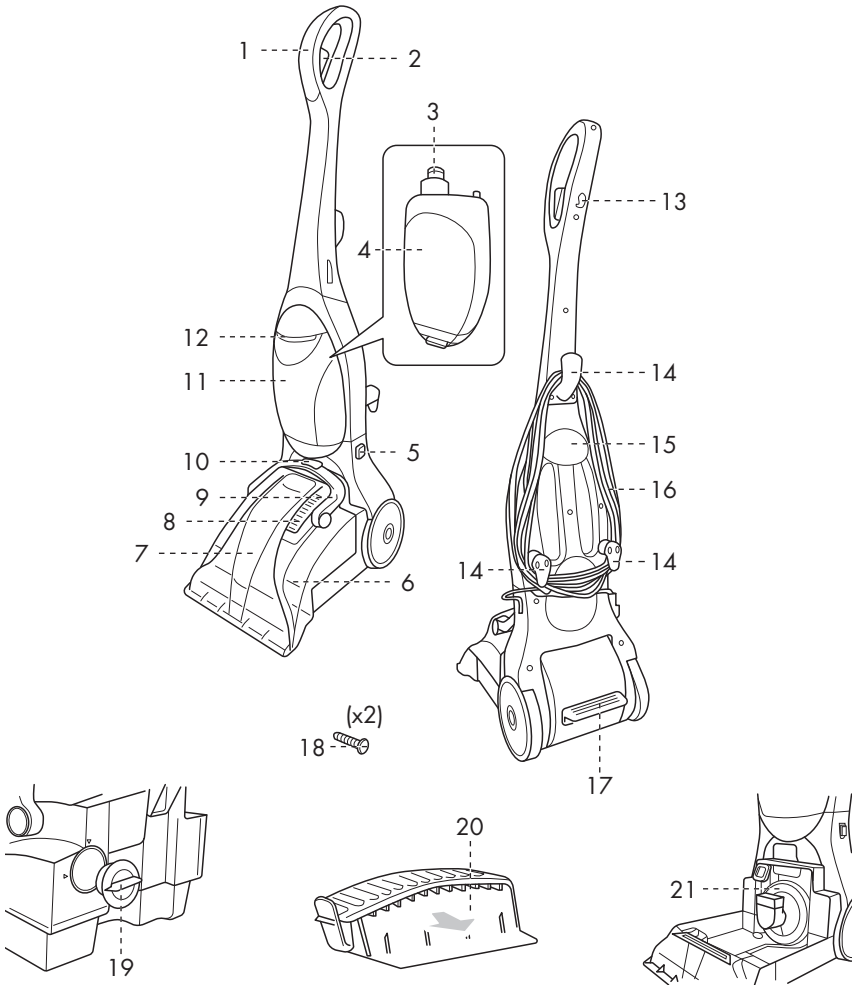

- |   |                                    |
|---|------------------------------------|
| 1. Handle                               | 12. Clean Water Tank Release Lever |
| 2. Clean Water/Solution Release Trigger | 13. Cord Clip                      |
| 3. Clean Water Tank Cap                 | 14. Cord Hooks                     |
| 4. Max. Filling Line (FULL)             | 15. Carry Handle                   |
| 5. ON / OFF Switch                      | 16. Power Cord                     |
| 6. Full Line                            | 17. Handle Release Pedal           |
| 7. Dirty Water Tank                     | 18. Handle Screw (x2)              |
| 8. Exhaust Filter Housing               | 19. Dirty Water Tank Cap           |
| 9. Dirty Water Tank Handle              | 20. Filter                         |
| 10. Dirty Water Tank Locking Hatch      | 21. Motor Filter                   |
| 11. Clean Water Tank                    |                                    |

Required Tools (not included): Phillips Screwdriver

**Improper handling of the product may cause injury.**

- Do not connect the product to a mains socket until it is fully assembled
- Do not operate the product without the handle being firmly screwed into place

1. Set the product in an upright position
2. Place the handle (1) firmly onto the main body of the product (see below). Make sure that the cord clip (13) is on the same side as the cord hooks (14)
3. Using a Phillips head screwdriver, drive one screw (18) into each side of the handle and fasten them securely (see diagram)  
Do not overtighten the screws, as this could strip the screw holes

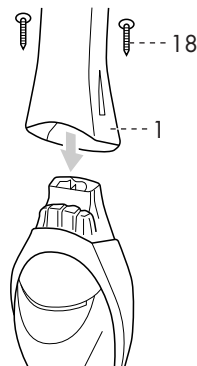

**CARPET PREPARATION**

**Risk of Damage!**

- Using the product as a dry vacuum will damage it
  - Only use the product with an appropriate carpet cleaning solution
1. Remove as much furniture as possible. Place plastic or other protective covering under and around any furniture left in the room
  2. Thoroughly vacuum the carpet to be cleaned with a regular vacuum cleaner
  3. Dampen a white cloth with the carpet cleaning solution you intend to use
  4. Rub the cloth gently over a small test area on the carpet and check for any colour bleeding. If the cloth remains clean, it should be safe to clean the carpet



## FILLING THE CLEAN WATER TANK

### Risk of Injury!

- Improper handling of the product may cause injury
- Always unplug the product before filling the clean water tank
- Avoid prolonged skin contact with cleaning solutions
- Keep carpet cleaning solution out of the reach of children
- In case of contact with eyes, rinse immediately with plenty of water and seek medical advice

### Risk of Damage!

Using the product without the clean water tank in place or with a wrong solution may damage the product

- Always make sure that the clean water tank is properly in place before using the product
- Do not use any solvents, cleaners with strong acidic or strong alkali formulas, or any type of cleaning solution not specifically for use in carpet cleaning machines
- Only use suitable (low-foaming) carpet cleaning solution. Using incorrect solutions may cause excess foaming, which will prevent the product from working effectively
- Most low foaming carpet cleaning solutions found in your local supermarket can be used
- Always read the manufacturer's instructions before use

1. Unplug the product
2. Lift up on the clean water tank release lever (12) and then remove the clean water tank (11) from the product (see diagram)
3. Unscrew and then remove the clean water tank cap 3 from the clean water tank
4. Following the instructions on the bottle, add cleaning solution and then fill the clean water tank with warm tap water (max. 40 °C). Do not fill over the maximum filling line (FULL) (4).
5. Replace the clean water tank cap
6. Place the clean water tank back into position by pushing it down until it clicks into place
7. Repeat the steps above (except step 4) to empty the clean water tank after use and before storage

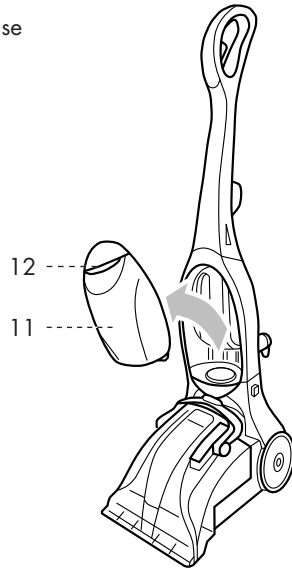

## CLEANING A CARPET

Before cleaning, determine where to start and stop, making sure you will not walk over previously cleaned areas.

- Do not oversaturate the carpet with the cleaning solution
  - For heavily soiled areas, additional applications may be necessary
1. Plug the mains cord (16) into a mains socket and turn the product on by setting the on/off switch 5 to the ON position (I)
  2. Step on the handle top release pedal (17) to lower the handle (1) into the cleaning position (see diagram)
  3. While pressing the solution release trigger (2), pull the product in a backwards direction towards you. This will deliver clean water down to the carpet.
  4. Release the solution release trigger and push the product forward in the same path to remove the dirty cleaning solution from the carpet
  5. Repeat steps 3–4 to clean other parts of the carpet or heavily soiled areas.
  6. When cleaning is done, turn the product off by setting the on/off switch to the OFF position (O)
  7. Push the handle forward until it is positioned upright and locked into place
  8. Unplug the product and wrap the mains cord around the cord hooks (14)

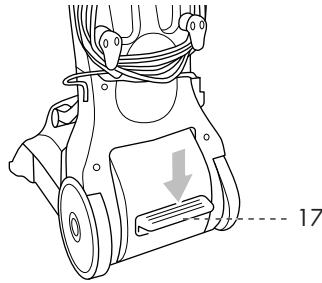

## TIPS FOR CARPET CLEANING

- Use the carrying handle (15) to lift up the product and move it to the desired cleaning location
- Do not run the product over the mains cord (16) by holding any excess cord in your freehand while cleaning
- Use a steady, moderate, forwards and backwards motion
- Always work from back to front across a room to avoid stepping on wet carpet
- Do not make the carpet too wet. Use no more than two sets of forwards and backwards strokes while releasing the carpet cleaning solution. Always follow with dry strokes; the more dry strokes the better
- Wipe any cleaning solution from woodwork and furniture to prevent any damage
- Allow plenty of time for the carpet to dry and avoid walking on it until it is dry
- Increased air circulation (open doors, fans, etc.) or the use of a dehumidifier will help the carpet dry thoroughly and prevent the growth of mould or mildew
- If the carpet is not dry and the furniture must be placed back in the room, use plastic or foil under the furniture to prevent staining the carpet
- Vacuum the carpet thoroughly before cleaning it and after it has dried

## EMPTYING THE DIRTY WATER TANK

**Risk of injury!** Improper handling of the product may cause injury.

- Always unplug the product before emptying the dirty water tank
  - An automatic shut-off device prevents the product from picking up more dirty water than the dirty water tank can hold. You will know the dirty water tank needs to be emptied when:
    - the motor sound rises in pitch,
    - the dirty solution has reached the FULL line (6) in the dirty water tank
1. Unplug the product
  2. Unlock the dirty water tank (7) by pressing the dirty water tank locking latch (10) and lifting up the dirty water tank handle (9) at the same time (see Fig. A)
  3. Remove the dirty water tank from the product
  4. Open the dirty water tank cap (20) by turning it anticlockwise, so the grip points to the word "unlock" (see Fig. B)
  5. Empty the dirty water tank, replace the dirty water tank cap and turn it to the "lock" position. Then place the dirty water tank back into the product (see Fig. C)
  6. Push the dirty water tank handle down until the dirty water tank locking latch clicks into place

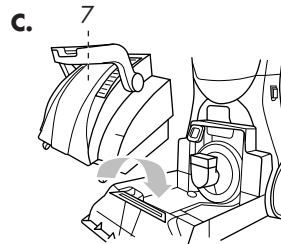
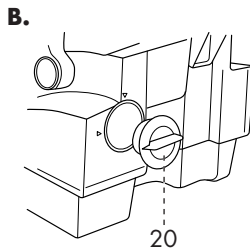
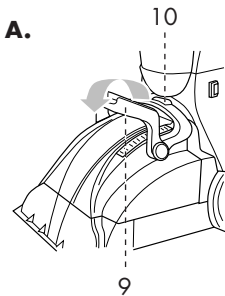

**Risk of injury!** Improper handling of the product may cause injury.

- Always unplug the product when not in use, refilling the tanks, cleaning it, or performing maintenance

**Risk of damage!** Improper handling of the product may cause damage.

- Do not use any aggressive cleaners, brushes with metal or nylon bristles, or sharp or metallic cleaning utensils such as knives, hard scrapers and the like. They could damage the surfaces
- Never immerse the motor unit in water or any other liquids and do not rinse it under the tap or with a hose

**CLEANING THE FILTERS**

Do not clean the filters with any chemicals as this will destroy them

1. Remove the dirty water tank (7) as described in chapter “EMPTYING THE DIRTY WATER TANK”
2. Remove the exhaust filter housing (8) from the dirty water tank (see Fig. D)
3. Pull out the filter (21) from the exhaust filter housing (see Fig. E)
4. Rinse the filter with warm water (max. 40 °C). Allow the filter to dry thoroughly
5. Replace the filter and put the exhaust filter housing back into the dirty water tank
6. With the dirty water tank still removed, pull out the motor filter (22) (see Fig. F)
7. Rinse the motor filter with warm water. Allow the motor filter to dry thoroughly
8. Replace the motor filter and put the dirty water tank back into the product as described in chapter “EMPTYING THE DIRTY WATER TANK”

**CLEANING THE PRODUCT**

1. Unplug the product
2. Make sure the clean water tank (11) and the dirty water tank (7) are empty (see chapter “FILLING THE CLEAN WATER TANK” and “EMPTYING THE DIRTY WATER TANK”)
3. Use a soft damp cloth to wipe off the product and accessories. Then let all parts dry completely

**NOTE: Do not use harsh solvents to clean the plastic.**

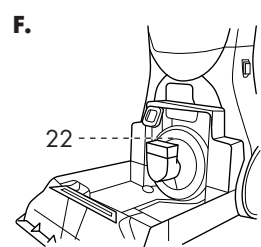
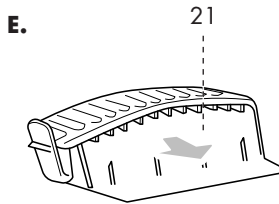
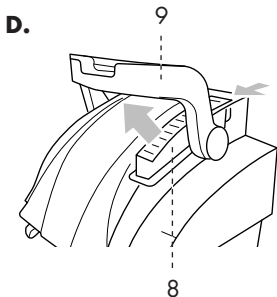

This appliance requires little maintenance. It contains no user-serviceable parts. Any servicing requiring disassembly other than cleaning must be performed by a qualified appliance repair engineer.

### **STORE IN A SAFE PLACE**

When not in use, store your appliance and all its accessories and instruction manual in a safe and dry place

Mineral deposits and mildew can form when cleaning solution and/ or water is left in the tanks, affecting the performance of the product.

- Do not store the product with the cleaning solution left in the clean water tank or dirty water left in the dirty water tank
- You can lift and carry the carpet washer using the carrying handle. Never pull or lift the appliance by the cord
- Before putting the appliance away, Switch off the socket, unplug, and wrap the cord around the storage hooks

If you experience difficulties with the appliance, please check the suggestions below before contacting customer services on 01473 271272:

PROBLEM	POSSIBLE CAUSES	SOLUTIONS/TIPS
Loss of suction power	Brush malfunction	Make sure brush roll and brush roll cover installed correctly, clean brush roll and debris channel
	The sponge for pre-filter is dirty	Clean the pre-filter
	The dirty water tank has picked up maximum amount of dirty water and has reached MAX line	Empty the dirty water then reinstall the dirty water tank
	Brush cover is not latched in place	Reinstall brush cover
	The debris channel or the airway is blocked	Remove blockages
Machine makes unusual noises during normal usage	The debris channel or the airway is blocked	Remove blockages
	The dirty water tank has picked up maximum amount of dirty water and has reached MAX line	Empty the dirty water then reinstall the dirty water tank
Machine won't charge	The external charger cord not correctly plugged	Unplug the charger, then plug again into the machine and then into the wall outlet
Machine won't spray	The clean water tank may be empty	Refill clean water tank
	The clean water tank may not be installed correctly	Install the clean water tank correctly

PROBLEM	POSSIBLE CAUSES	SOLUTIONS/TIPS
Air outlet cover is leaking water	Then floater or the sponge for pre-filter may not be installed	Install the floater and the sponge correctly
	The dirty water tank has picked up maximum amount of dirty water and has reached MAX line	Empty the dirty water then reinstall the dirty water tank
	The sponge for Pre-filter is moist	Let the sponge dry out
	The floater is blocked	Remove blockages



### **Danger!**

Never try to repair a defective appliance yourself. You can put yourself and/or future users in danger. Repairs must only be done by a service engineer.

Model:	EW3070 HYDROC1
Rated Voltage:	220-240V~50-60Hz
Power Consumption:	500W
Protection Class:	II
IP Protection:	IPX4
Clean Water Tank:	1.6L to FULL line (Max. capacity 2.3L)
Dirty Water Tank:	1.8L to FULL line (Max. capacity 2.5L)
Product Dimensions:	H:1080 x W:420 x D:250mm
Net Weight:	5.7 kg



### Fuse Replacement (Class II)

Remove the fuse cover with a small flat head screw driver. Take out the fuse and replace with a new fuse of the same Amp. Replace the fuse cover and push back into place.

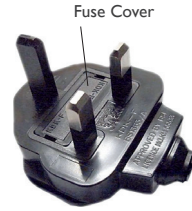

### Disposal Information

The European Directive 2012/19/EU on Waste Electrical and Electronic Equipment (WEEE), requires that old household electrical appliances must not be disposed of in normal unsorted municipal waste.

Old appliances must be collected separately in order to optimise the recovery and recycling of the materials they contain and reduce the impact on human health and the environment.

The crossed out "wheeled bin" symbol on the product reminds you of your obligation, that when you dispose of the appliance it must be separately collected. Consumers should contact their local authority or retailer for information concerning the correct disposal of their old appliance.





## **Ewbank Warranty Terms & Conditions**

This product is guaranteed for a period of 24 months as standard from the date of purchase against mechanical and electrical defects.

To qualify for the warranty, the product must be used for domestic household use only and in accordance with the instructions in the user manual. Any misuse of the product will result in the warranty being void.

The warranty does not cover accidental damage, misuse, neglect, tampering or incorrect adjustment or installation.

The warranty will be rendered invalid if the product is resold, has had its serial number removed (or has an invalid serial number), or if an unauthorised person has carried out any repairs or alterations.

The warranty does not cover accessories or consumable parts that require replacement under normal use. This includes shelving, dials, filters, belts and trays etc.

In the unlikely event of a breakdown please refer to the Troubleshooting guide in your user manual and check all plugs, fuses and the electricity supply.

If you still require assistance please contact our Customer Service department on **01473 271 272** or write to us at the following address:

**Customer Service Department  
Ewbank, 38 Bluestem Road,  
Ipswich, Suffolk, IP3 9RR**

Please quote the Product Code and the PO Number on the rating label and give details of the exact fault. We will then decide whether to repair or replace the item.

Before we arrange the repair or replacement you will be required to return a copy of your proof of purchase. Please retain your original.

If an item is replaced within the agreed warranty period, the warranty for the replacement item will be calculated from the purchase date of the original.

In the event that the product is inspected and no fault is found or the product is not within the warranty period you will be charged for the repair and any carriage costs.





## Your Guarantee

This product is covered by a 2 year guarantee.

This does not cover normal wear and tear or abuse.

For guarantee purposes, please retain your original receipt as proof of purchase.

This guarantee does not affect your statutory rights.

For spares, service and further information please contact;

Ewbank, 38 Bluestem Road, Ipswich, Suffolk, IP3 9RR

EU: Castle Electrical Factors Ltd., Dundalk, A91 KA9R, IR

Tel: 01473 271 272

Disclaimer: Ewbank operate a policy of continual improvement and development.

We therefore reserve the right to change/alter the specification and appearance of our appliances without prior notice.

All diagrams and images shown in this manual are for illustration purposes only.